

EXPLODED DIAGRAM - PARTS VIEW

Sales Model: MASF048-N1
Power Supply: 115V / 60Hz

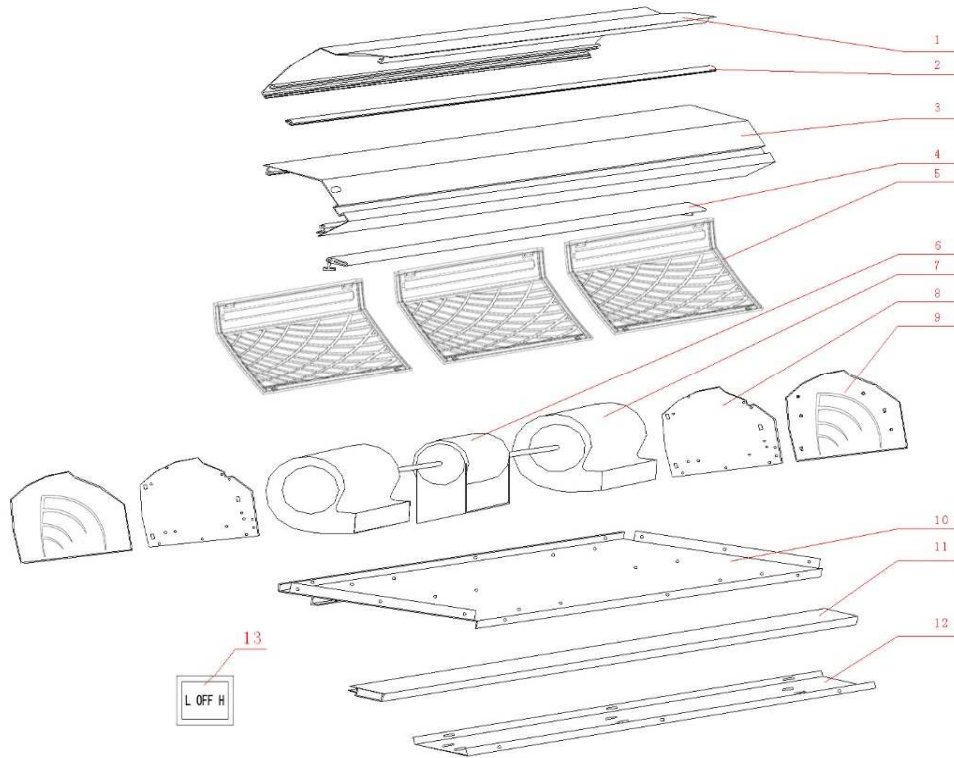

This information is to be used by qualified HVAC technicians only and is subject to revision without notice

MASF048-N1
 Drawing D2SF1403

No.	Part No.	Description	Specification	Unit Price	Remarks
1		Cover panel		\$45.00	
2		Decorative articles		\$20.00	
3		Front board		\$40.00	
4		Wind leader		\$20.00	
5		Wind Grill		\$20.00	
6		Left and right side cover		\$20.00	
7		Blower		\$25.00	
8		Motor		\$70.00	
9		Turbine			
10		Left and right side board		\$15.00	
11		Outlet			
12		Mounting plate		\$25.00	
13		Support board		\$20.00	
14		Mounting plate		\$35.00	
15		Switch		\$20.00	

This information is to be used by qualified HVAC technicians only and is subject to revision without notice. Above prices are subject to S&H charges

MASF048-N1 - Parts List P2SF1403
 Date 14-01