



# KSID MINI Split DC Inverter QUICK CONNECT Air Conditioner

## TROUBLESHOOTING

### Model Numbers:

KSID012-H115Q

KSID016-H215Q

KSID022-H215Q



### WARNING

Installation MUST conform with local building codes or, in the absence of local codes, with the National Electrical Code NFPA70/ANSI C1-1993 or current edition and Canadian Electrical Code Part1 CSA C.22.1.

The information contained in the manual is intended for use by a qualified service technician familiar with safety procedures and equipped with the proper tools and test instruments. Installation or repairs made by unqualified persons can result in hazards to you and others. Failure to carefully read and follow all instructions in this manual can result in equipment malfunction, property damage, personal injury and/or death.

This service is only for service engineer to use.



## 9. Troubleshooting

### Safety

Electricity power is still kept in capacitors even the power supply is shut off. Do not forget to discharge the electricity power in capacitor.

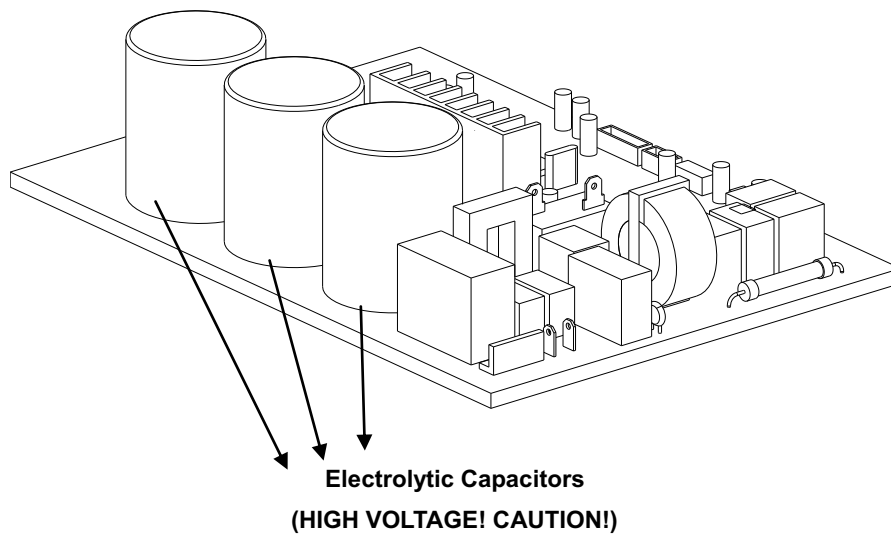

For other models, please connect discharge resistance (approx. 100Ω 40W) or soldering iron (plug) between +, - terminals of the electrolytic capacitor on the contrary side of the outdoor PCB.

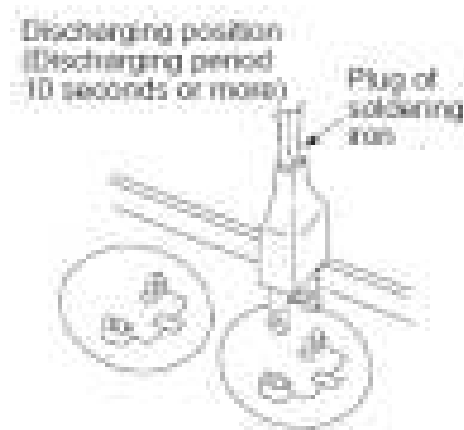

**Note: The picture above is only for reference. The plug of your side may be different.**

## 9.1 Indoor Unit Error Display

Operation lamp	Timer lamp	Display	LED STATUS
☆ 1 time	X	E0	Indoor unit EEPROM parameter error
☆ 2 times	X	E1	Indoor / outdoor units communication error
☆ 3 times	X	E2	Zero-crossing signal detection error
☆ 4 times	X	E3	Indoor fan speed has been out of control
☆ 5 times	X	E4	Indoor room temperature sensor T1 open circuit or short circuit
☆ 6 times	X	E5	Evaporator coil temperature sensor T2 open circuit or short circuit
☆ 7 times	X	EC	Refrigerant leakage detection
☆ 2 times	O	F1	Outdoor temperature sensor T4 open circuit or short circuit
☆ 3 times	O	F2	Condenser coil temperature sensor T3 open circuit or short circuit
☆ 4 times	O	F3	Compressor discharge temperature sensor T5 open circuit or short circuit
☆ 5 times	O	F4	Outdoor unit EEPROM parameter error
☆ 1 times	☆	P0	IPM malfunction or IGBT over-strong current protection
☆ 2 times	☆	P1	Over voltage or over low voltage protection
☆ 3 times	☆	P2	High temperature protection of compressor top diagnosis and solution(only for KSID022-H215Q-I models)
☆ 5 times	☆	P4	Inverter compressor drive error

## 9.2 Outdoor unit error display KSID012-H115Q-O:

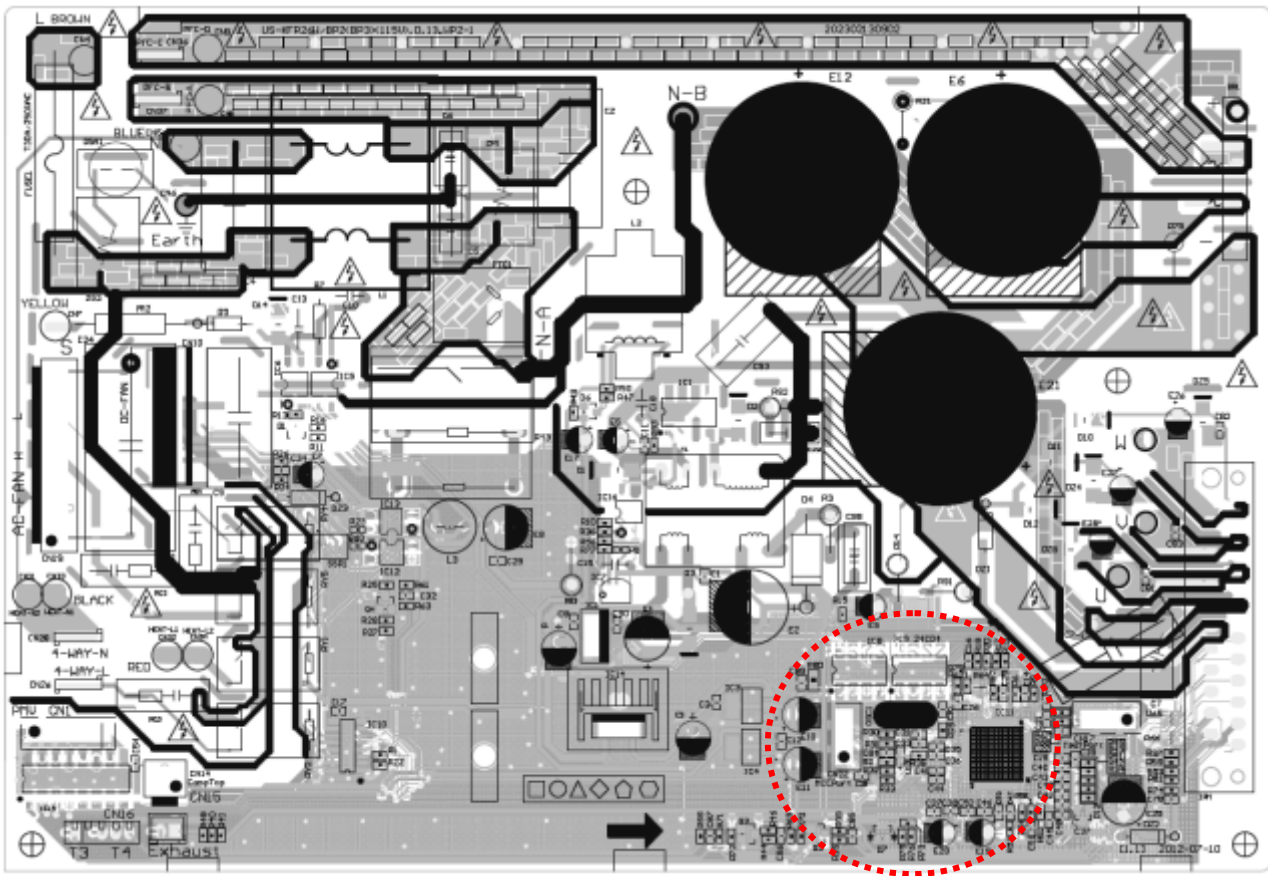

There's a LED light on the outdoor PCB which is blue color. After power on, it will be slow flash(0.2Hz) when the unit is in standby and quick flash (2.5Hz) if the unit has some problems.

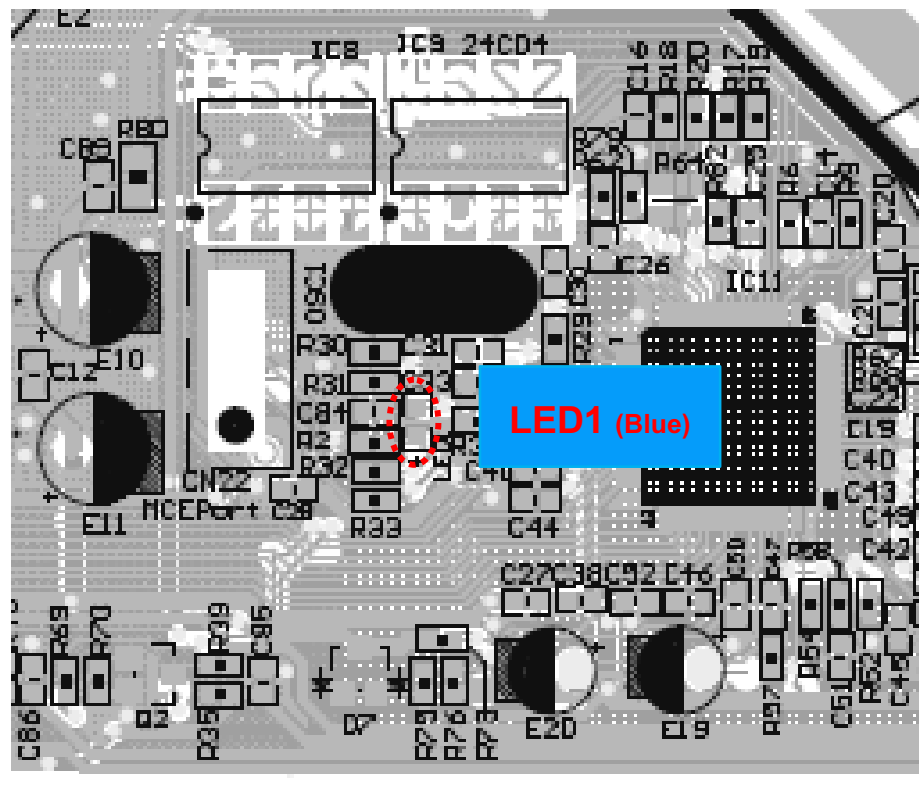

KSID016-H215Q-O:

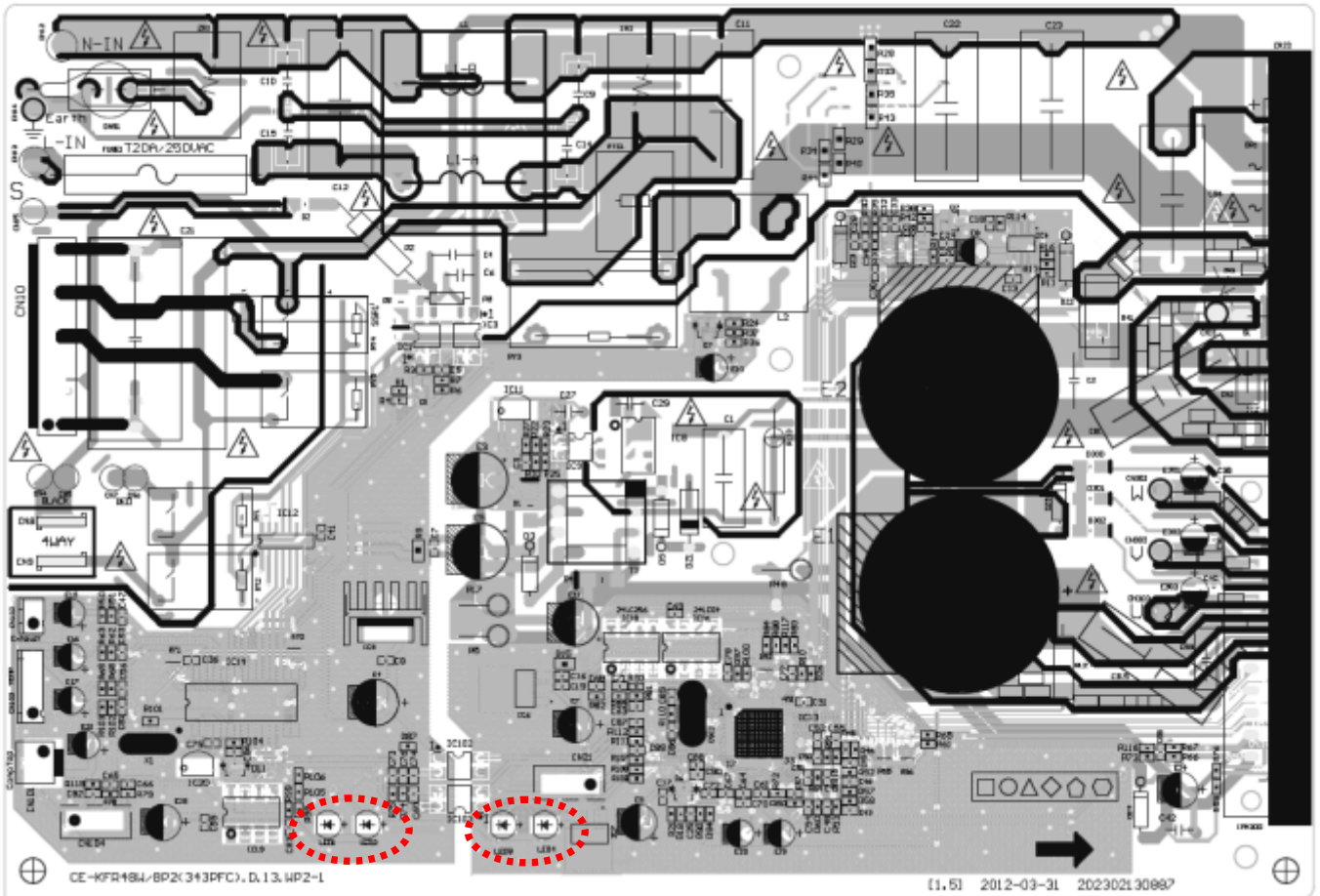

LED4 (red)

LED1 (yellow)

LED5 (red) & LED6 (green)

	standby	operating
LED1	slow flashing(0.2Hz)	on
LED4	on	on

The picture of PCB above is only for reference.

LED 4 is a red light and for the PCB POWER display.

LED 1 is a yellow light. After power on, it will be slow flash (0.2Hz) when the unit is in standby and quick flash (2.5Hz) if the unit has some problems.

LED 6(green) and LED5 (red) are two lights controlled by the compressor drive chip. Below are meanings for those lights.

No.	Problems	LED6 (Green)	LED5 (Red)	IU display
1	standby for normal	O	X	
2	Operation normally	X	O	
3	IPM malfunction or IGBT over strong current protection	☆	X	P0
4	Over voltage or too low voltage protection	O	O	P1
5	Over voltage or too low voltage protection	O	☆	P1
6	Inverter compressor drive error	X	☆	P4
7	Inverter compressor drive error	☆	O	P4
8	Inverter compressor drive error	☆	☆	P4

O (light)

X (off)

☆ (2.5Hz flash)

**KSID022-H215Q-O:**

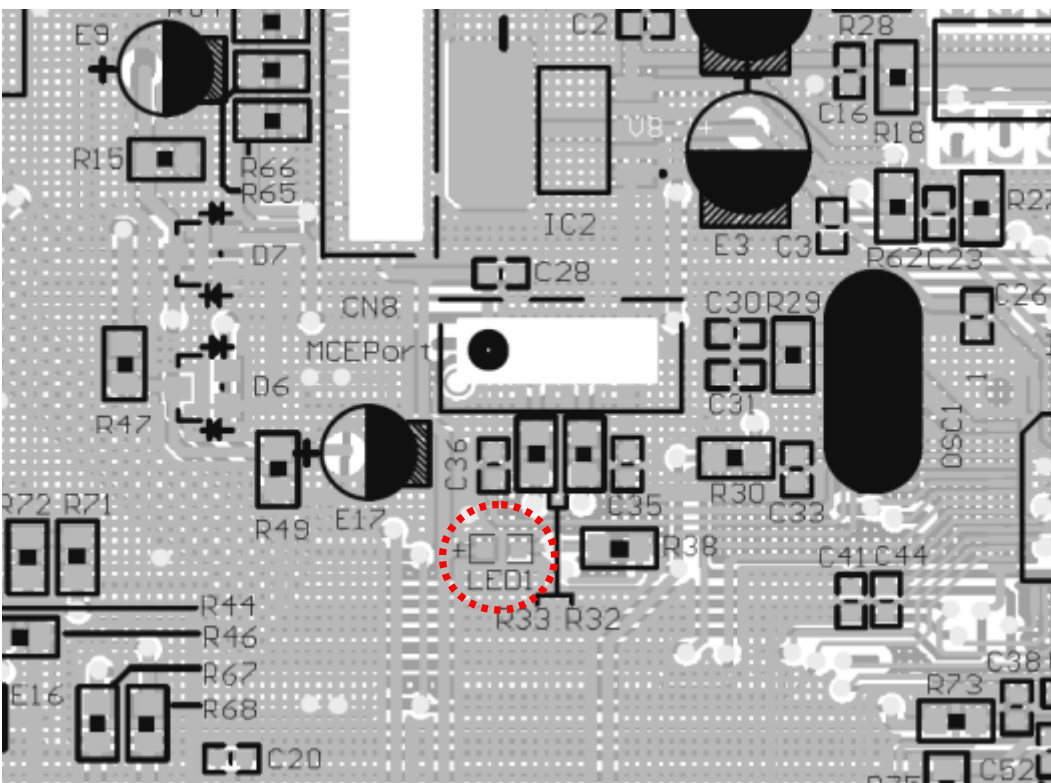
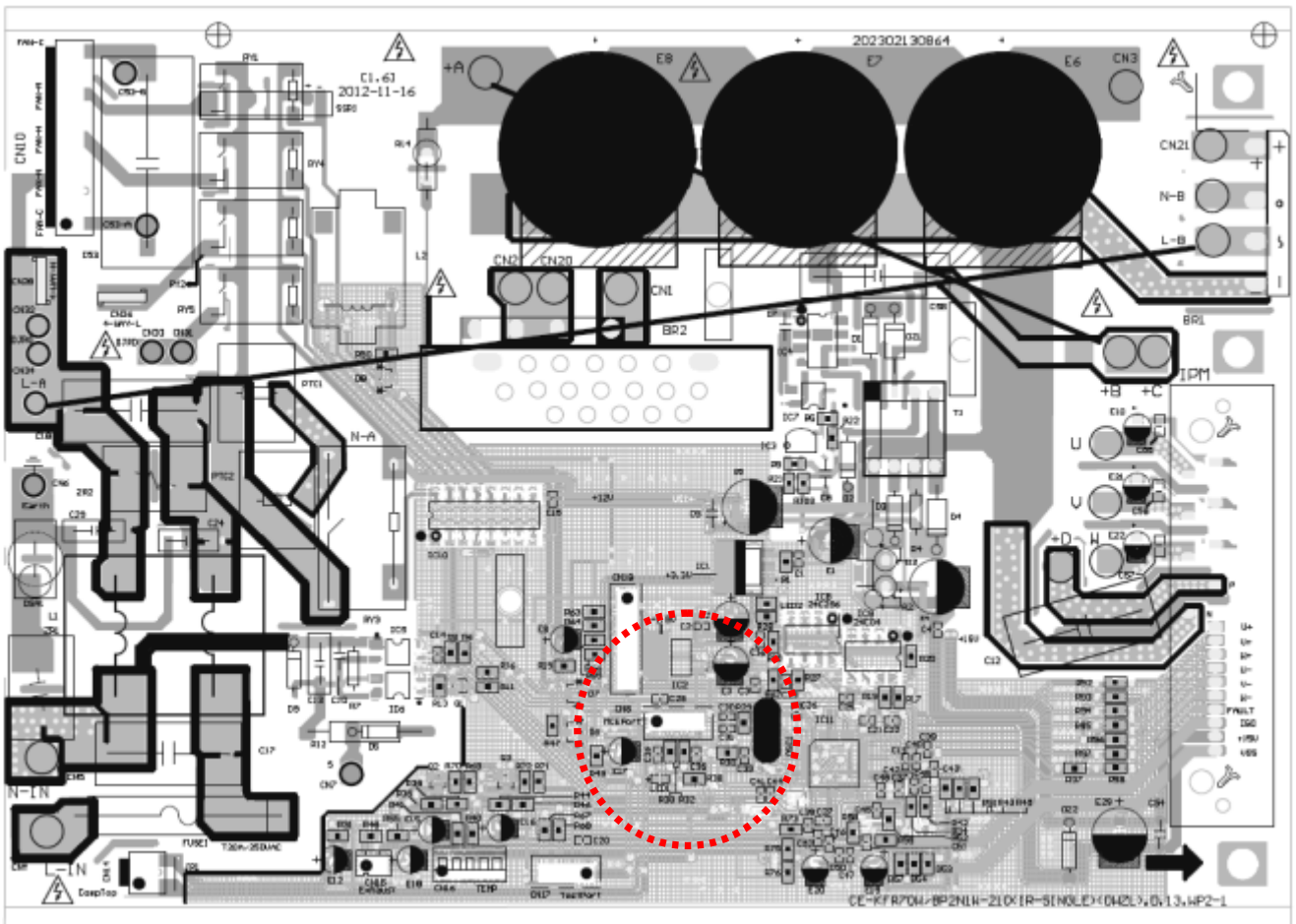

There's a LED light on the outdoor PCB which is blue color. After power on, it will be slow flash (0.2Hz) when the unit is in standby and quick flash (2.5Hz) if the unit has some problems.

### 9.3 Diagnosis and Solution

#### 9.3.1 EEPROM parameter error diagnosis and solution (E0/F4)

<b>Error Code</b>	<b>E0/F4</b>
<b>Malfunction decision conditions</b>	<b>Indoor or outdoor PCB main chip does not receive feedback from EEPROM chip.</b>
<b>Supposed causes</b>	<ul style="list-style-type: none"> <li>● Installation mistake</li> <li>● PCB faulty</li> </ul>

#### Trouble shooting:

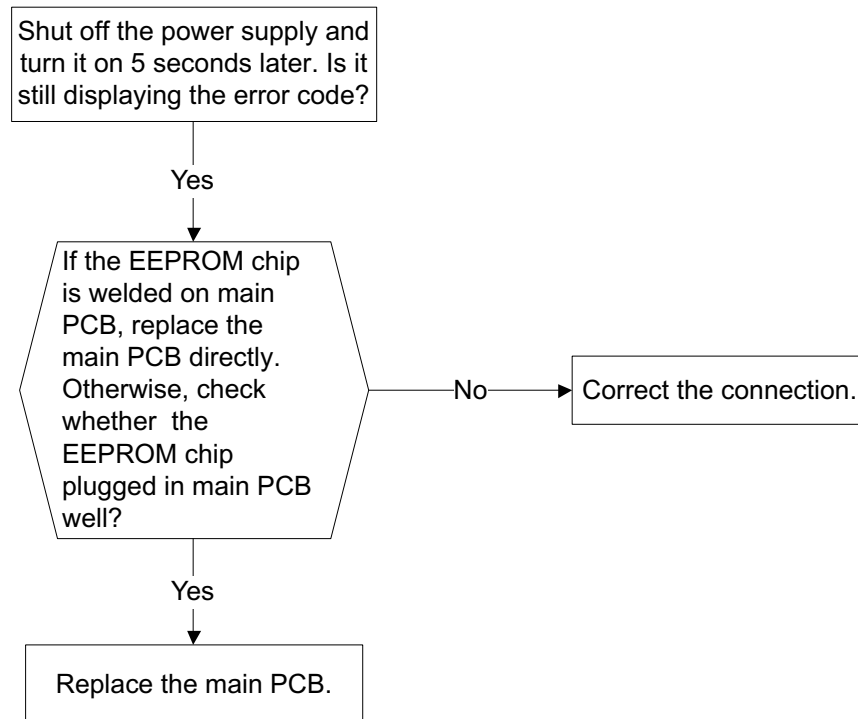

EEPROM: a read-only memory whose contents can be erased and reprogrammed using a pulsed voltage. For the location of EEPROM chip, please refer to the below photos.



Indoor PCB



Outdoor PCB KSID016-H215Q-O



### 9.3.2 Indoor / outdoor unit's communication diagnosis and solution (E1)

<b>Error Code</b>	<b>E1</b>
<b>Malfunction decision conditions</b>	<b>Indoor unit does not receive the feedback from outdoor unit during 110 seconds and this condition happens four times continuously.</b>
<b>Supposed causes</b>	<ul style="list-style-type: none"> <li>● <b>Wiring mistake</b></li> <li>● <b>Indoor or outdoor PCB faulty</b></li> </ul>

**Trouble shooting:**

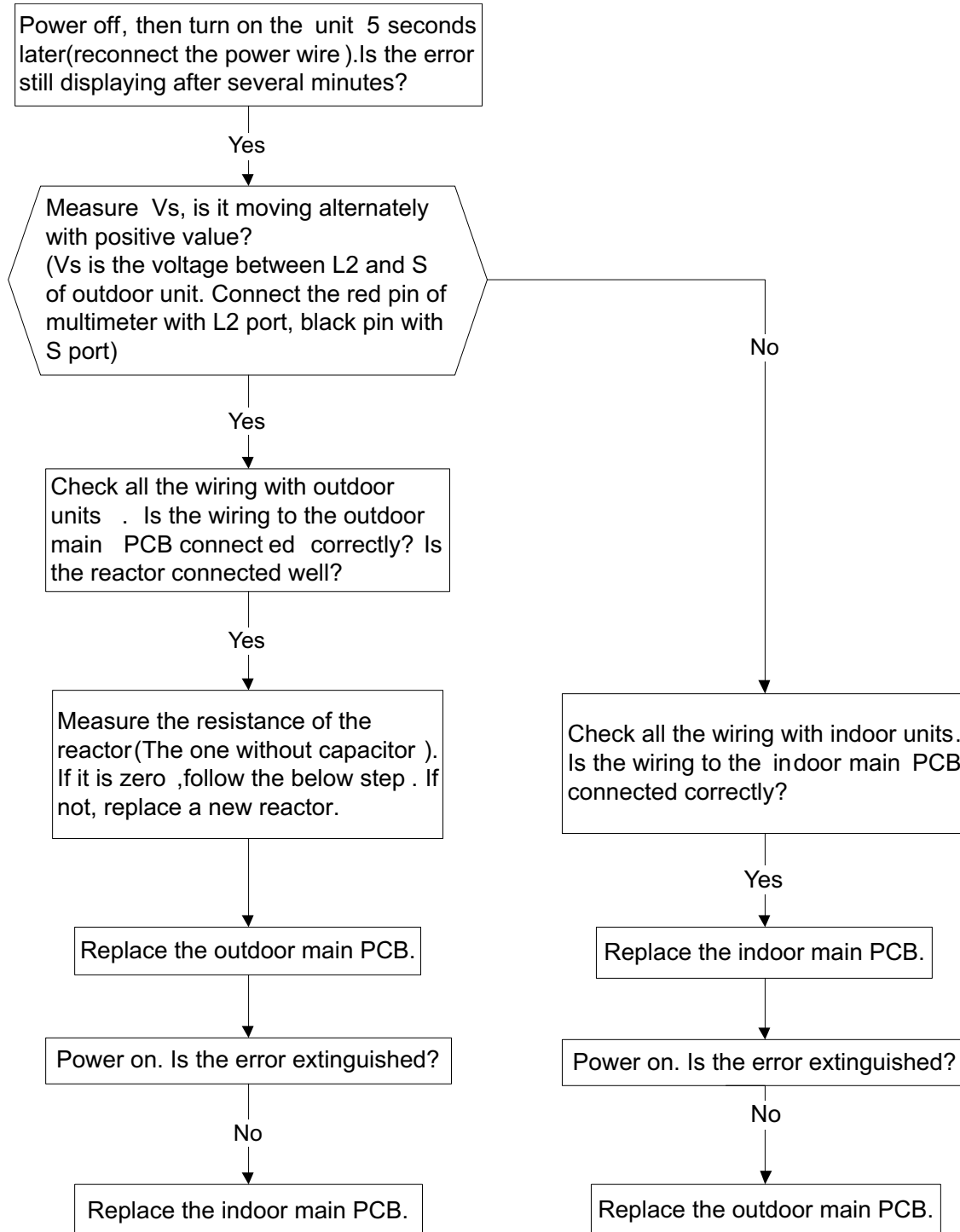



**Remark:**

Use a multi-meter to test the DC voltage between L2 port and S port of outdoor unit. The red pin of multi-meter connects with L2 port while the black pin is for S port.

When AC is normal running, the voltage will move alternately between -50V to 50V.

If the outdoor unit has malfunction, the voltage will move alternately with positive value.

While if the indoor unit has malfunction, the voltage will be a certain value.



**Remark:**

Use a multi-meter to test the resistance of the reactor which does not connect with capacitor. The normal value should be around zero ohm. Otherwise, the reactor must have malfunction and need to be replaced.

### 9.4.3 Zero crossing detection error diagnosis and solution (E2)

<b>Error Code</b>	<b>E2</b>
<b>Malfunction decision conditions</b>	<b>When PCB does not receive zero crossing signal feedback for 4 minutes or the zero crossing signal time interval is abnormal.</b>
<b>Supposed causes</b>	<ul style="list-style-type: none"><li>● <b>Connection mistake</b></li><li>● <b>PCB faulty</b></li></ul>

#### Trouble shooting:

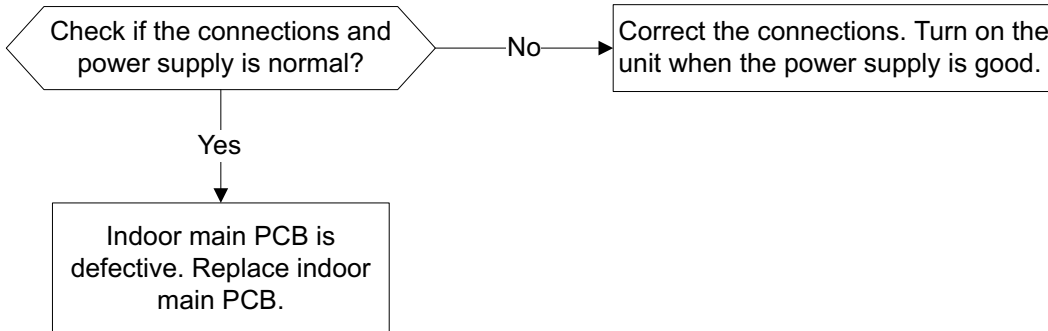

### 9.4.4 Fan speed has been out of control diagnosis and solution (E3)

<b>Error Code</b>	<b>E3</b>
<b>Malfunction decision conditions</b>	<b>When indoor fan speed keeps too low (300RPM) for certain time, the unit will stop and the LED will display the failure.</b>
<b>Supposed causes</b>	<ul style="list-style-type: none"> <li>● <b>Wiring mistake</b></li> <li>● <b>Fan assembly faulty</b></li> <li>● <b>Fan motor faulty</b></li> <li>● <b>PCB faulty</b></li> </ul>

#### Trouble shooting:

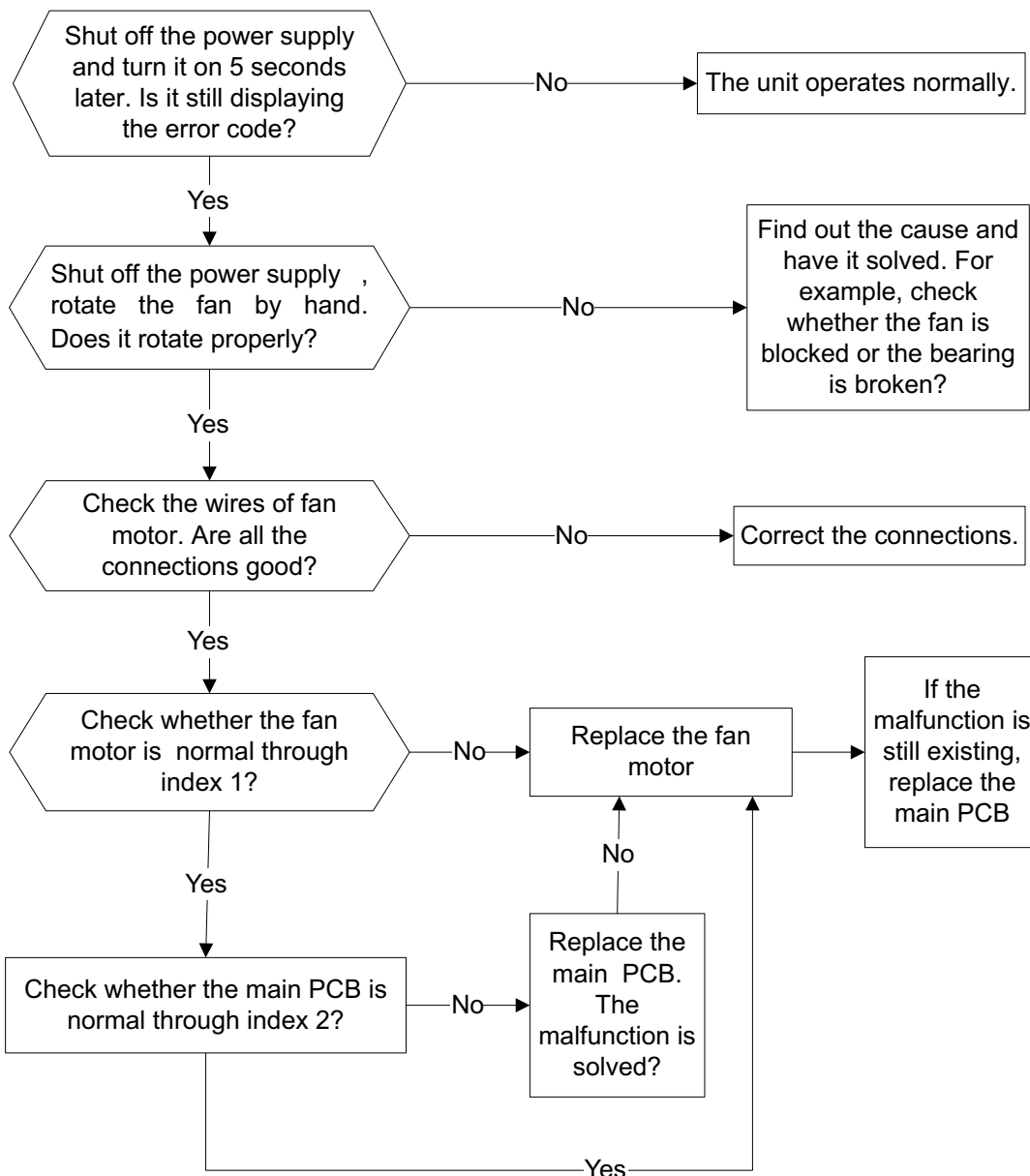

Index 1:

1. Indoor AC fan motor

Measure the resistance value of each winding by using the tester.

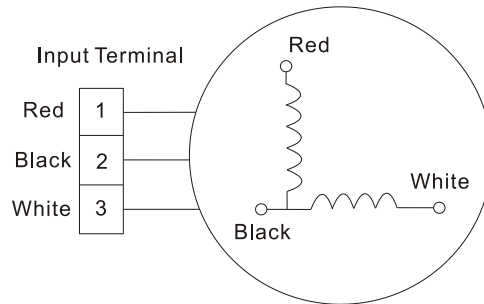

For the definite value of the resistance, refer to page61 and page64.

Index2:

1: Indoor AC fan motor

Power on and set the unit running in fan mode at high fan speed. After running for 15 seconds, measure the voltage of pin1 and pin2. If the value of the voltage is less than 100V(208~240V power supply)or 50V(115V power supply), the PCB must have problems and need to be replaced.

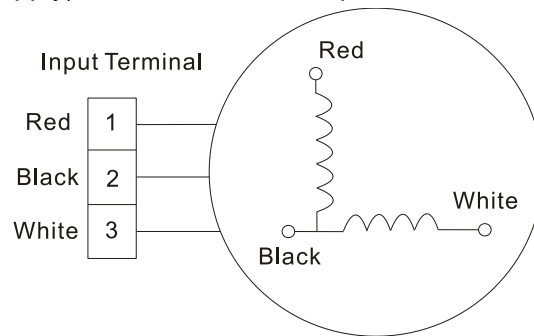

### 9.4.5 Open circuit or short circuit of temperature sensor diagnosis and solution (E5)

<b>Error Code</b>	<b>E5</b>
<b>Malfunction decision conditions</b>	If the sampling voltage is lower than 0.06V or higher than 4.94V, the LED will display the failure.
<b>Supposed causes</b>	<ul style="list-style-type: none"> <li>● Wiring mistake</li> <li>● Sensor faulty</li> <li>● PCB faulty</li> </ul>

#### Trouble shooting:

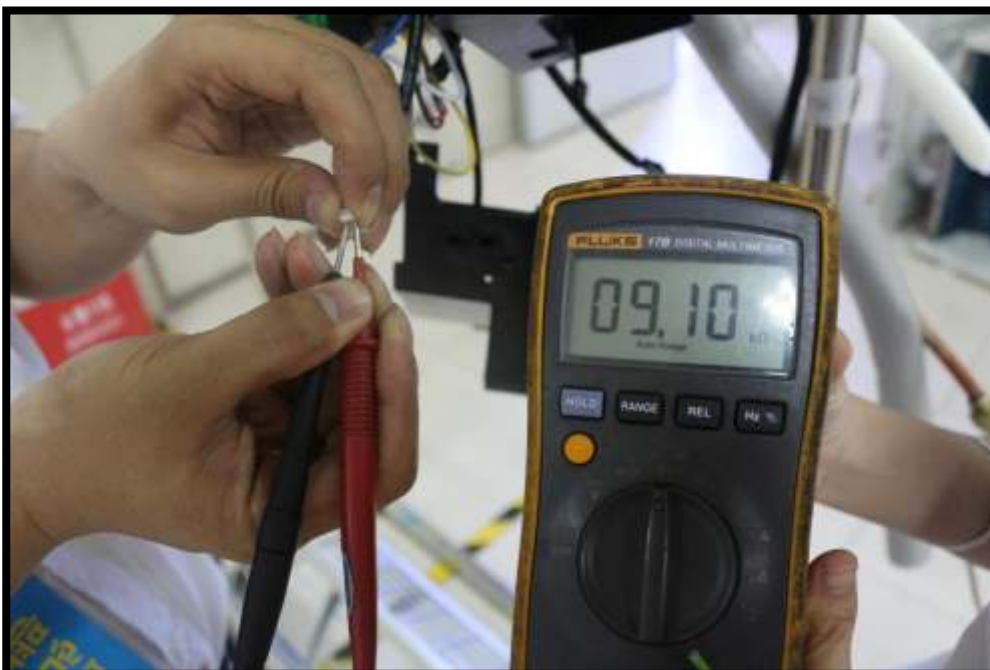
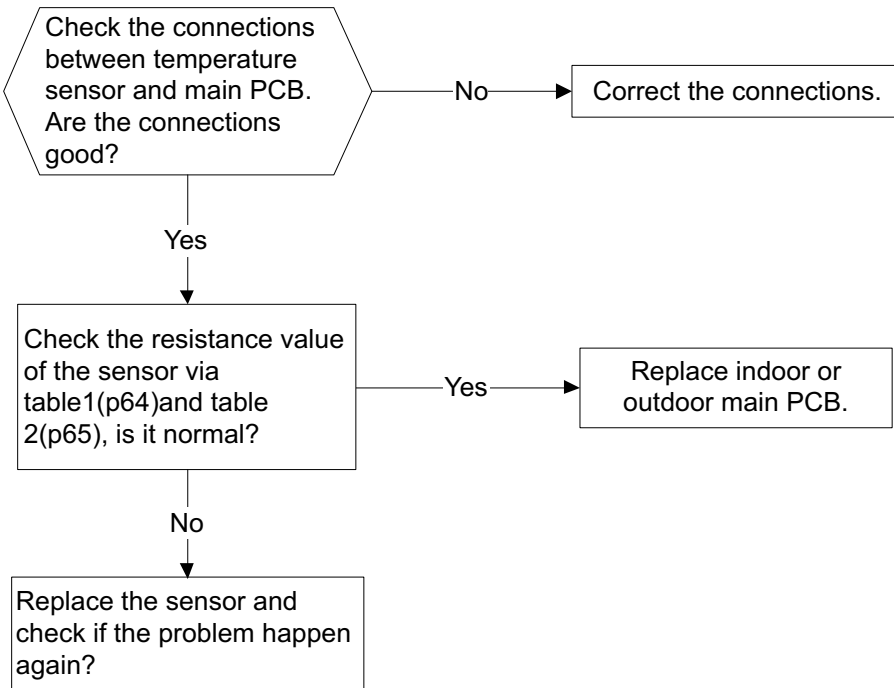

### 9.4.6 Refrigerant Leakage Detection diagnosis and solution (EC)

<b>Error Code</b>	<b>EC</b>
<b>Malfunction decision conditions</b>	<p>Define the evaporator coil temp.T2 of the compressor just starts running as Tcool.</p> <p>In the beginning 5 minutes after the compressor starts up, if <math>T2 &lt; T_{cool} - 2^{\circ}\text{C}</math> does not keep continuous 4 seconds and this situation happens 3 times, the display area will show “EC” and AC will turn off.</p>
<b>Supposed causes</b>	<ul style="list-style-type: none"> <li>● T2 sensor faulty</li> <li>● Indoor PCB faulty</li> <li>● System problems, such as leakage or blocking.</li> </ul>

#### Trouble shooting:

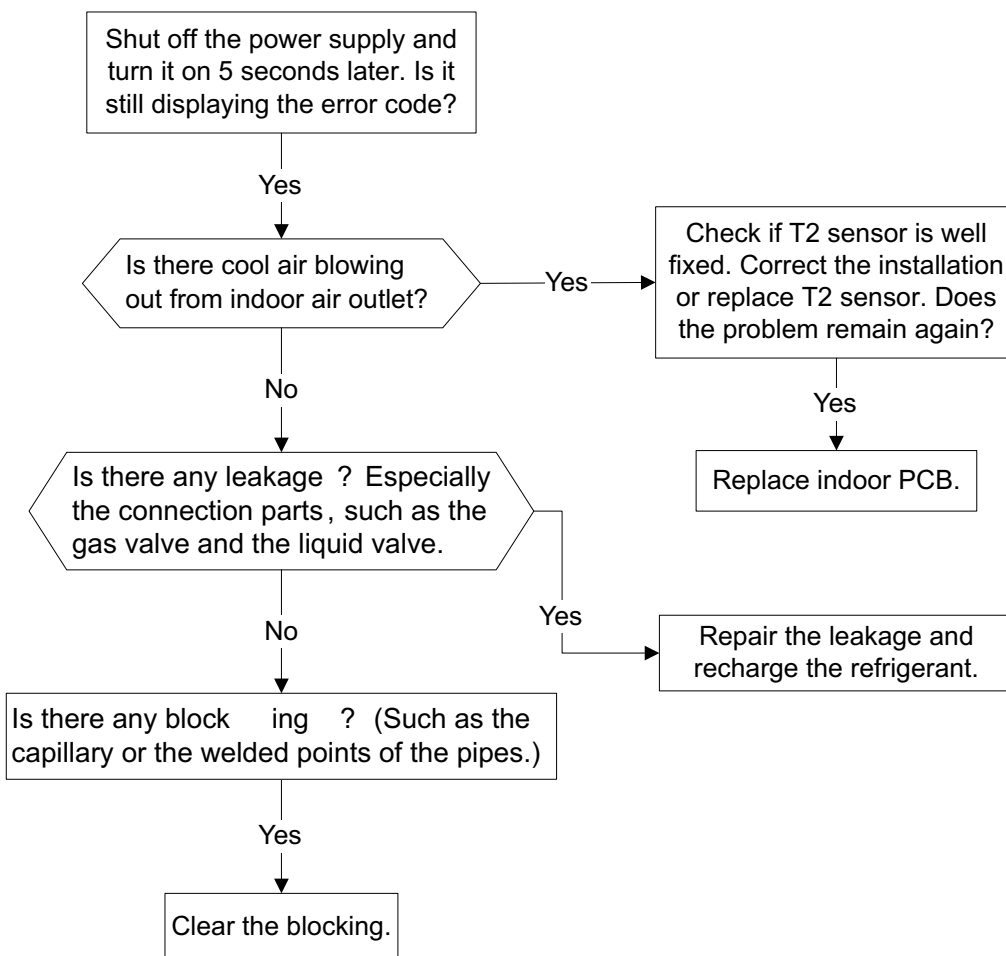

### 9.4.7 IPM malfunction or IGBT over-strong current protection diagnosis and solution (P0)

<b>Error Code</b>	<b>P0</b>
<b>Malfunction decision conditions</b>	<b>When the voltage signal that IPM send to compressor drive chip is abnormal, the display LED will show “P0” and AC will turn off.</b>
<b>Supposed causes</b>	<ul style="list-style-type: none"> <li>● <b>Wiring mistake</b></li> <li>● <b>IPM malfunction</b></li> <li>● <b>Outdoor fan assembly faulty</b></li> <li>● <b>Compressor malfunction</b></li> <li>● <b>Outdoor PCB faulty</b></li> </ul>

#### Trouble shooting:

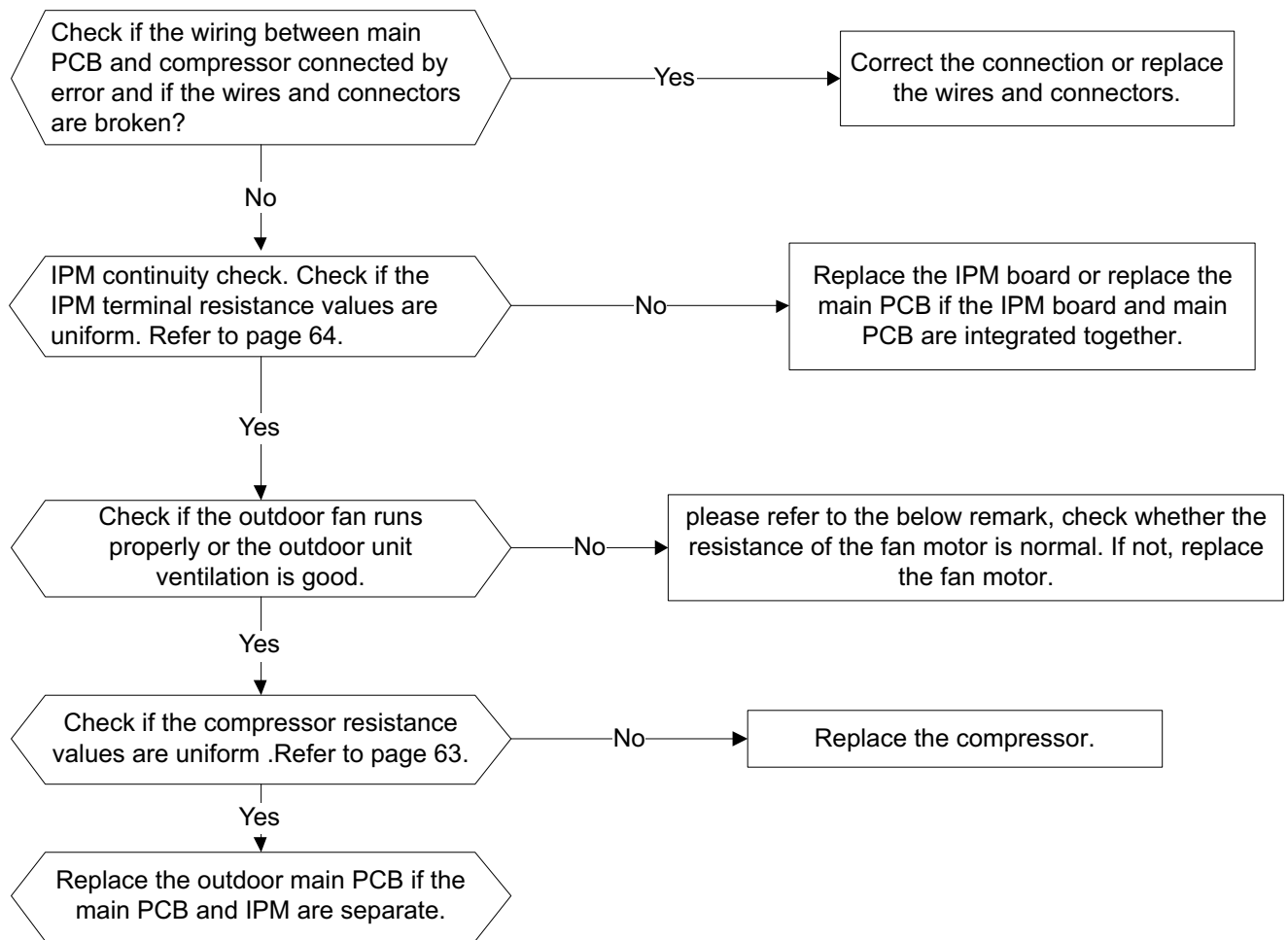

#### Remark:

- 1) KSID012-H115Q-I model: Measure the **black** pin and **red** pin of the motor connector, the resistance should be around **50Ω** at 20°C(68°F)
- 2) KSID016-H215Q-I model: Measure the **black** pin and **red** pin of the motor connector, the resistance should be around **84.5Ω** at 20°C(68°F)
- 3) KSID022-H215Q-I model: Measure the **black** pin and **red** pin of the motor connector, the resistance should be around **88.5Ω** at 20°C(68°F)

4)



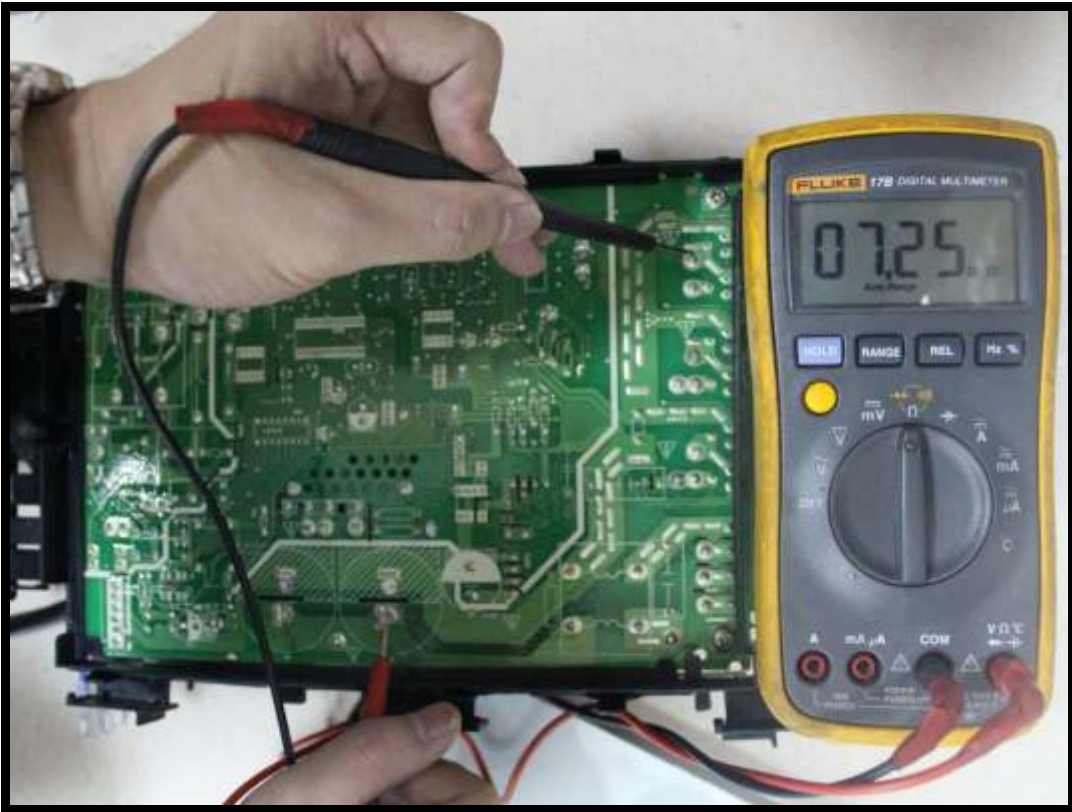

P-U

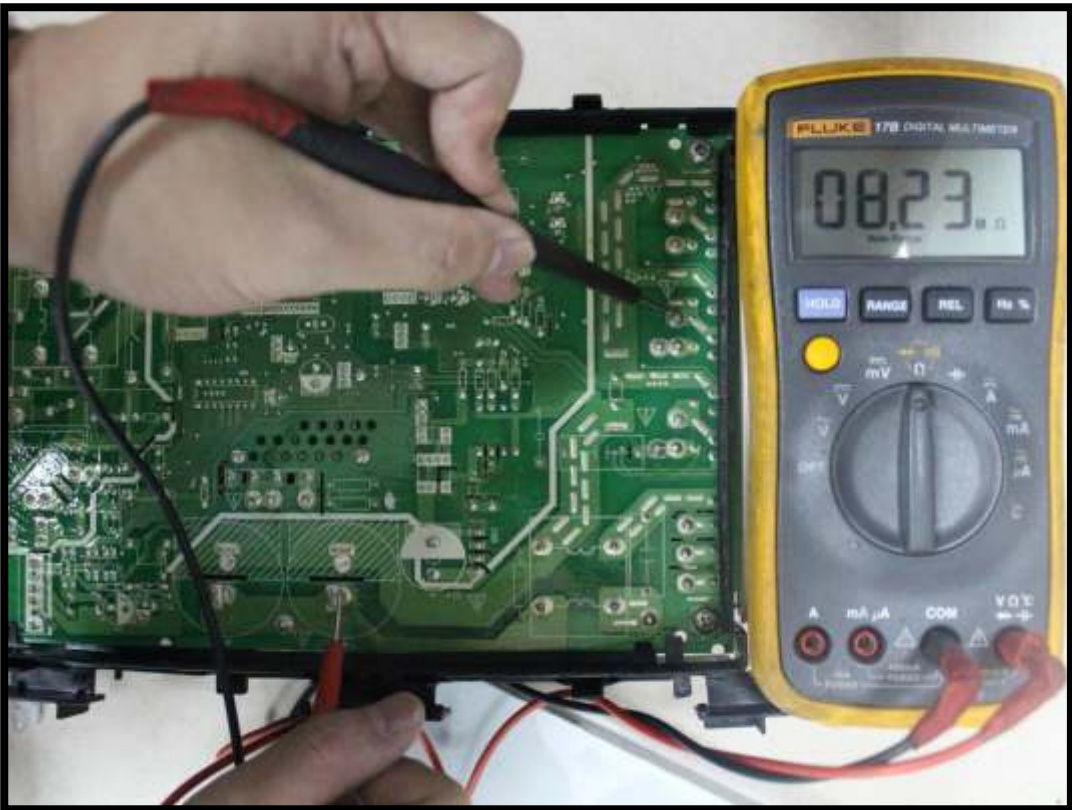

P-V

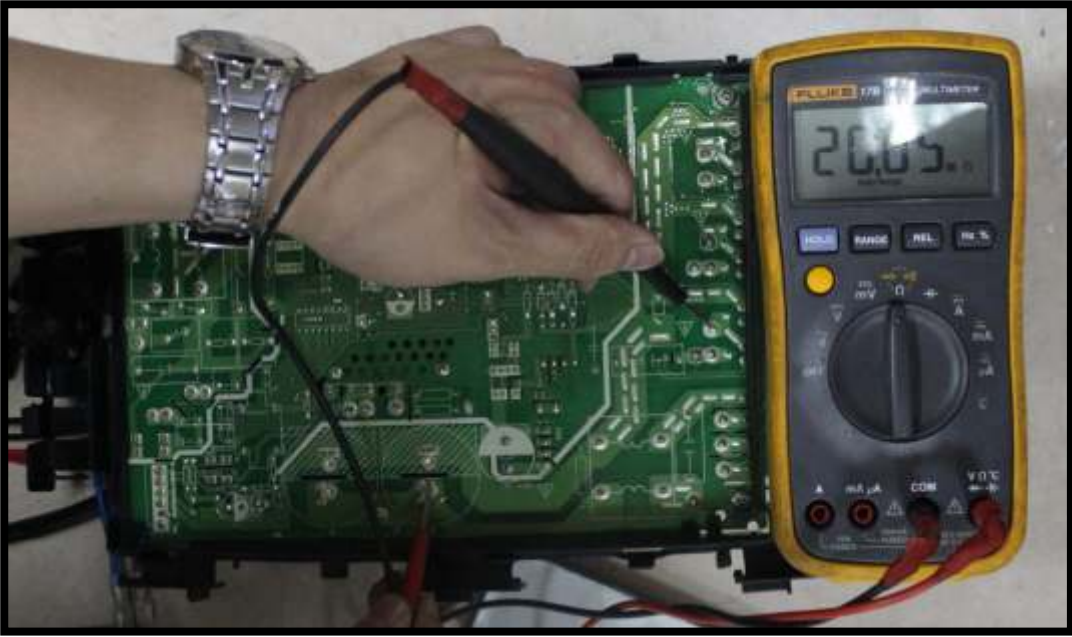

P-W

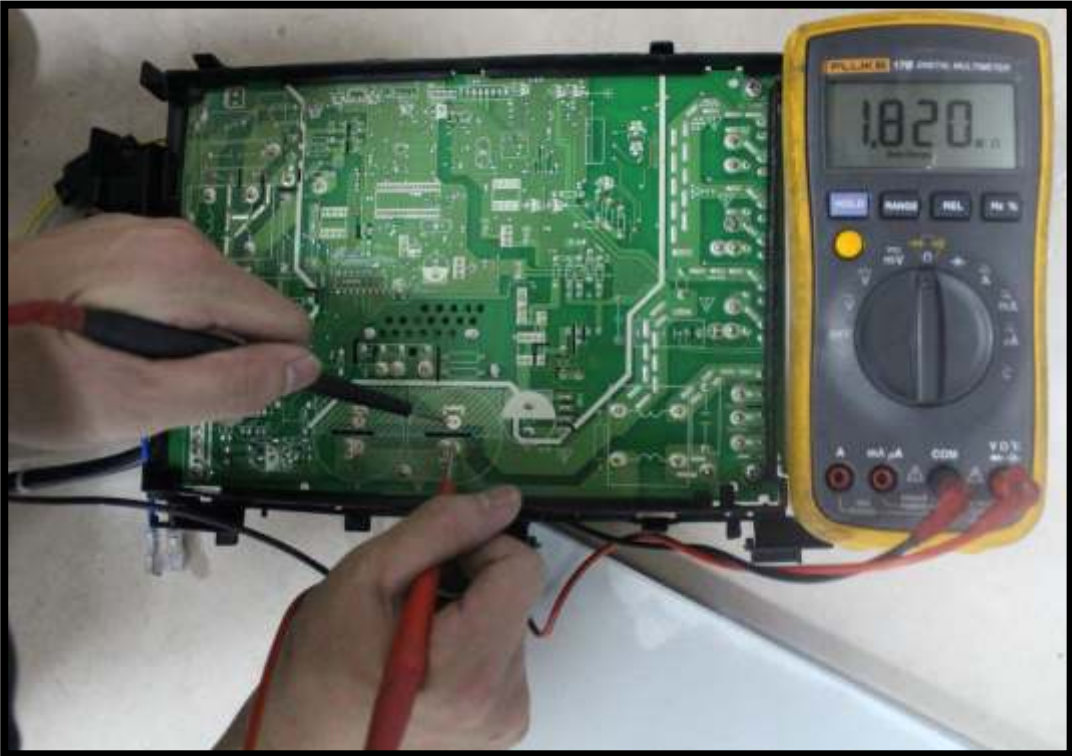

P-N

### 9.4.8 High temperature protection of compressor top diagnosis and solution (P2)

<b>Error Code</b>	<b>P2</b>
<b>Malfunction decision conditions</b>	<b>If the sampling voltage is not 5V, the LED will display the failure.</b>
<b>Supposed causes</b>	<ul style="list-style-type: none"> <li>● <b>Power supply problems.</b></li> <li>● <b>System leakage or block</b></li> <li>● <b>PCB faulty</b></li> </ul>

**Trouble shooting:**

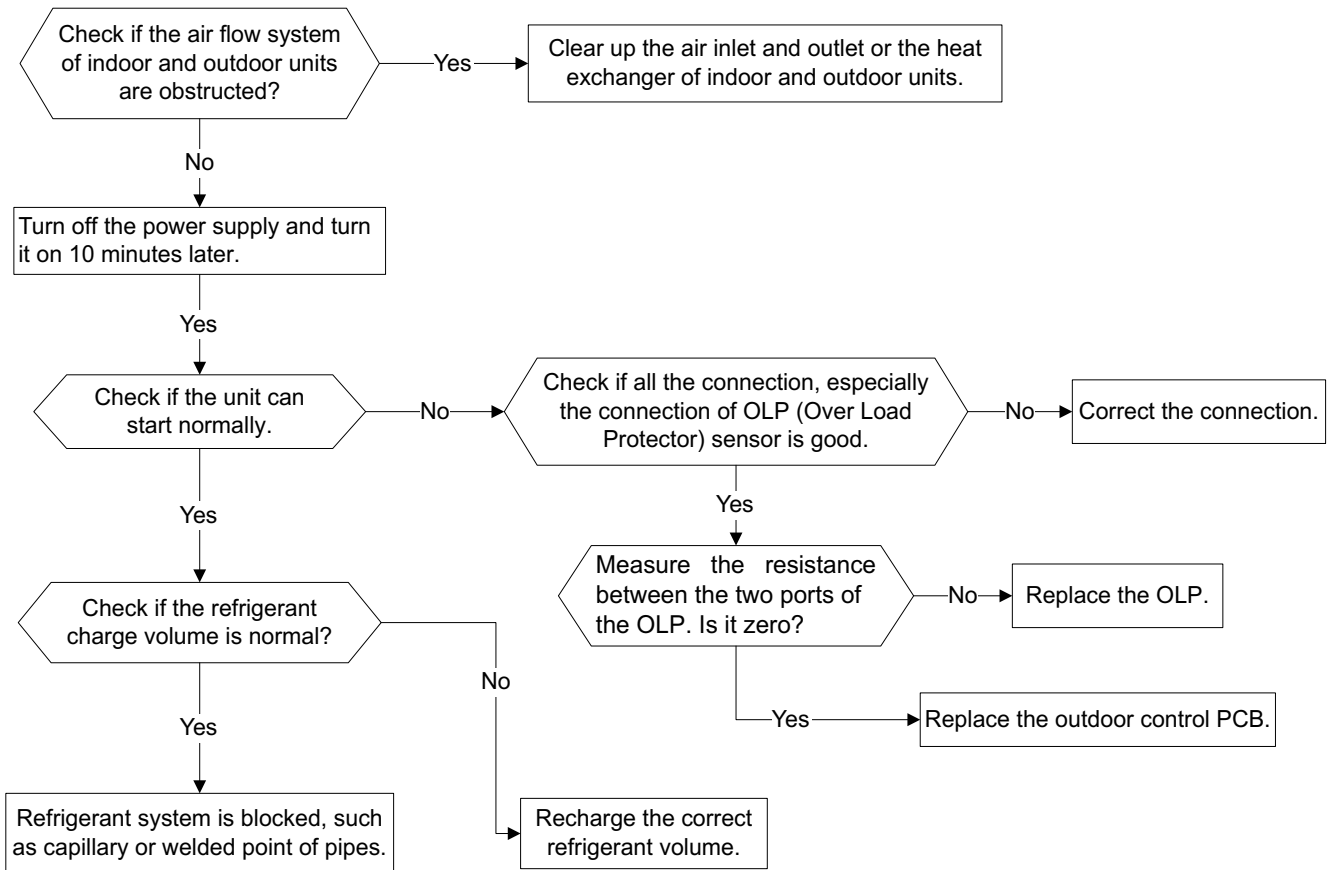

### 9.4.9 Inverter compressor drive error diagnosis and solution (P4)

<b>Error Code</b>	<b>P4</b>
<b>Malfunction decision conditions</b>	<b>An abnormal inverter compressor drive is detected by a special detection circuit, including communication signal detection, voltage detection, compressor rotation speed signal detection and so on.</b>
<b>Supposed causes</b>	<ul style="list-style-type: none"> <li>● <b>Wiring mistake</b></li> <li>● <b>IPM malfunction</b></li> <li>● <b>Outdoor fan ass'y faulty</b></li> <li>● <b>Compressor malfunction</b></li> <li>● <b>Outdoor PCB faulty</b></li> </ul>

#### Trouble shooting:

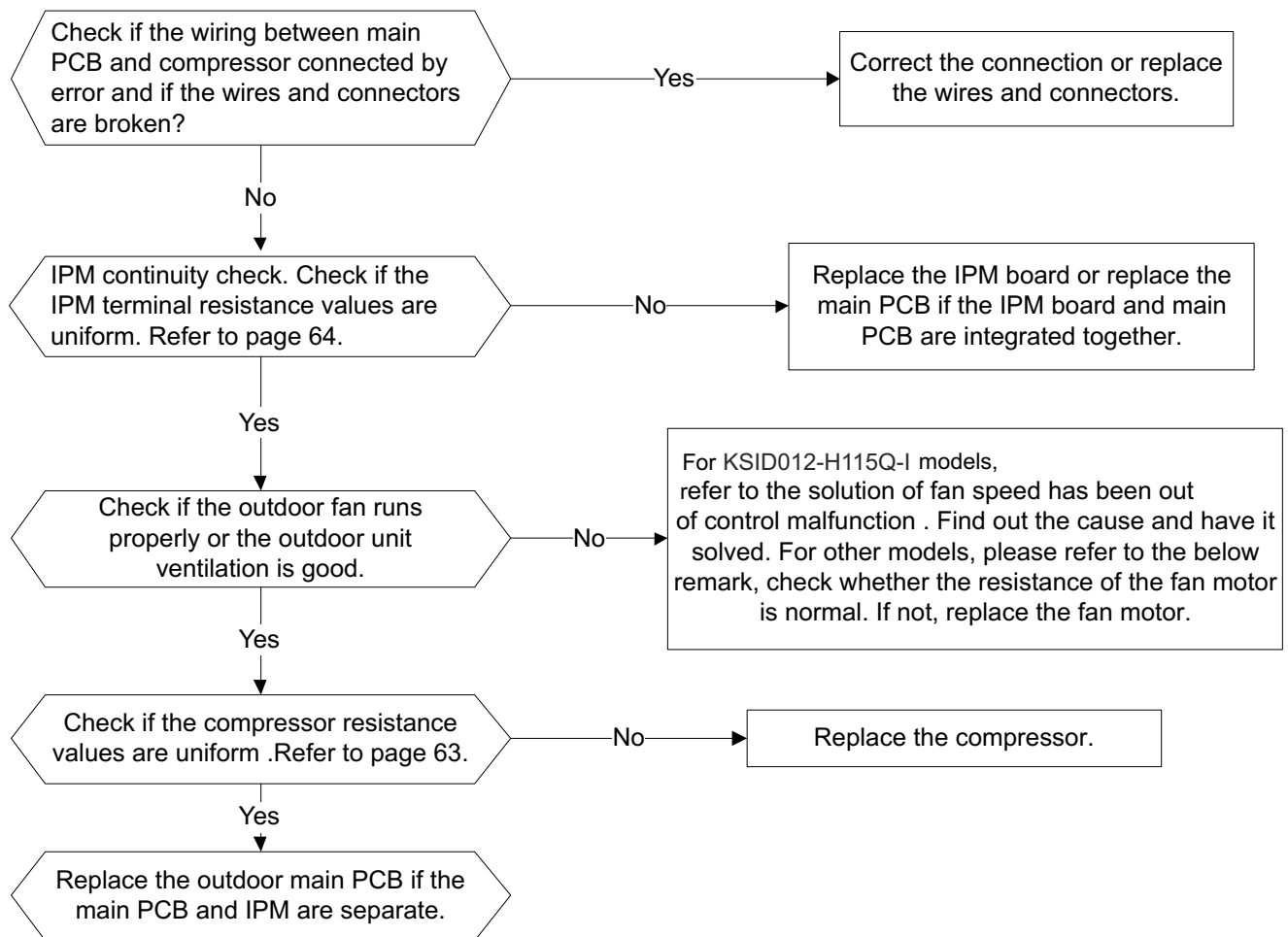

#### Remark:

- 1) KSID012-H115Q-I model: Measure the **black** pin and **red** pin of the motor connector, the resistance should be around **50Ω** at 20°C(68°F)
- 2) KSID016-H215Q-I model: Measure the **black** pin and **red** pin of the motor connector, the resistance should be around **84.5Ω** at 20°C(68°F)
- 3) KSID022-H215Q-I model: Measure the **black** pin and **red** pin of the motor connector, the resistance should be around **88.5Ω** at 20°C(68°F)

## Main parts check

### 2. Temperature sensor checking

Disconnect the temperature sensor from PCB, measure the resistance value with a tester.

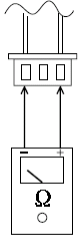

Tester

Temperature Sensors.

Room temp.(T1) sensor,

Indoor coil temp.(T2) sensor,

Outdoor coil temp.(T3) sensor,

Outdoor ambient temp.(T4) sensor,

Compressor discharge temp (T5) sensor.

Measure the resistance value of each winding by using the multi-meter.

**Appendix 1** Temperature Sensor Resistance Value Table for T1,T2,T3,T4 (°C--K)

°C	°F	K Ohm	°C	°F	K Ohm	°C	°F	K Ohm	°C	°F	K Ohm
-20	-4	115.266	20	68	12.6431	60	140	2.35774	100	212	0.62973
-19	-2	108.146	21	70	12.0561	61	142	2.27249	101	214	0.61148
-18	0	101.517	22	72	11.5	62	144	2.19073	102	216	0.59386
-17	1	96.3423	23	73	10.9731	63	145	2.11241	103	217	0.57683
-16	3	89.5865	24	75	10.4736	64	147	2.03732	104	219	0.56038
-15	5	84.219	25	77	10	65	149	1.96532	105	221	0.54448
-14	7	79.311	26	79	9.55074	66	151	1.89627	106	223	0.52912
-13	9	74.536	27	81	9.12445	67	153	1.83003	107	225	0.51426
-12	10	70.1698	28	82	8.71983	68	154	1.76647	108	226	0.49989
-11	12	66.0898	29	84	8.33566	69	156	1.70547	109	228	0.486
-10	14	62.2756	30	86	7.97078	70	158	1.64691	110	230	0.47256
-9	16	58.7079	31	88	7.62411	71	160	1.59068	111	232	0.45957
-8	18	56.3694	32	90	7.29464	72	162	1.53668	112	234	0.44699
-7	19	52.2438	33	91	6.98142	73	163	1.48481	113	235	0.43482
-6	21	49.3161	34	93	6.68355	74	165	1.43498	114	237	0.42304
-5	23	46.5725	35	95	6.40021	75	167	1.38703	115	239	0.41164
-4	25	44	36	97	6.13059	76	169	1.34105	116	241	0.4006
-3	27	41.5878	37	99	5.87359	77	171	1.29078	117	243	0.38991
-2	28	39.8239	38	100	5.62961	78	172	1.25423	118	244	0.37956
-1	30	37.1988	39	102	5.39689	79	174	1.2133	119	246	0.36954
0	32	35.2024	40	104	5.17519	80	176	1.17393	120	248	0.35982
1	34	33.3269	41	106	4.96392	81	178	1.13604	121	250	0.35042
2	36	31.5635	42	108	4.76253	82	180	1.09958	122	252	0.3413
3	37	29.9058	43	109	4.5705	83	181	1.06448	123	253	0.33246
4	39	28.3459	44	111	4.38736	84	183	1.03069	124	255	0.3239
5	41	26.8778	45	113	4.21263	85	185	0.99815	125	257	0.31559
6	43	25.4954	46	115	4.04589	86	187	0.96681	126	259	0.30754
7	45	24.1932	47	117	3.88673	87	189	0.93662	127	261	0.29974
8	46	22.5662	48	118	3.73476	88	190	0.90753	128	262	0.29216
9	48	21.8094	49	120	3.58962	89	192	0.8795	129	264	0.28482
10	50	20.7184	50	122	3.45097	90	194	0.85248	130	266	0.2777
11	52	19.6891	51	124	3.31847	91	196	0.82643	131	268	0.27078
12	54	18.7177	52	126	3.19183	92	198	0.80132	132	270	0.26408
13	55	17.8005	53	127	3.07075	93	199	0.77709	133	271	0.25757
14	57	16.9341	54	129	2.95896	94	201	0.75373	134	273	0.25125
15	59	16.1156	55	131	2.84421	95	203	0.73119	135	275	0.24512
16	61	15.3418	56	133	2.73823	96	205	0.70944	136	277	0.23916
17	63	14.6181	57	135	2.63682	97	207	0.68844	137	279	0.23338
18	64	13.918	58	136	2.53973	98	208	0.66818	138	280	0.22776
19	66	13.2631	59	138	2.44677	99	210	0.64862	139	282	0.22231

**Appendix 2 Temperature Sensor Resistance Value Table for T5 (°C--K)**

°C	°F	K Ohm	°C	°F	K Ohm	°C	°F	K Ohm	°C	°F	K Ohm
-20	-4	542.7	20	68	68.66	60	140	13.59	100	212	3.702
-19	-2	511.9	21	70	65.62	61	142	13.11	101	214	3.595
-18	0	483	22	72	62.73	62	144	12.65	102	216	3.492
-17	1	455.9	23	73	59.98	63	145	12.21	103	217	3.392
-16	3	430.5	24	75	57.37	64	147	11.79	104	219	3.296
-15	5	406.7	25	77	54.89	65	149	11.38	105	221	3.203
-14	7	384.3	26	79	52.53	66	151	10.99	106	223	3.113
-13	9	363.3	27	81	50.28	67	153	10.61	107	225	3.025
-12	10	343.6	28	82	48.14	68	154	10.25	108	226	2.941
-11	12	325.1	29	84	46.11	69	156	9.902	109	228	2.86
-10	14	307.7	30	86	44.17	70	158	9.569	110	230	2.781
-9	16	291.3	31	88	42.33	71	160	9.248	111	232	2.704
-8	18	275.9	32	90	40.57	72	162	8.94	112	234	2.63
-7	19	261.4	33	91	38.89	73	163	8.643	113	235	2.559
-6	21	247.8	34	93	37.3	74	165	8.358	114	237	2.489
-5	23	234.9	35	95	35.78	75	167	8.084	115	239	2.422
-4	25	222.8	36	97	34.32	76	169	7.82	116	241	2.357
-3	27	211.4	37	99	32.94	77	171	7.566	117	243	2.294
-2	28	200.7	38	100	31.62	78	172	7.321	118	244	2.233
-1	30	190.5	39	102	30.36	79	174	7.086	119	246	2.174
0	32	180.9	40	104	29.15	80	176	6.859	120	248	2.117
1	34	171.9	41	106	28	81	178	6.641	121	250	2.061
2	36	163.3	42	108	26.9	82	180	6.43	122	252	2.007
3	37	155.2	43	109	25.86	83	181	6.228	123	253	1.955
4	39	147.6	44	111	24.85	84	183	6.033	124	255	1.905
5	41	140.4	45	113	23.89	85	185	5.844	125	257	1.856
6	43	133.5	46	115	22.89	86	187	5.663	126	259	1.808
7	45	127.1	47	117	22.1	87	189	5.488	127	261	1.762
8	46	121	48	118	21.26	88	190	5.32	128	262	1.717
9	48	115.2	49	120	20.46	89	192	5.157	129	264	1.674
10	50	109.8	50	122	19.69	90	194	5	130	266	1.632
11	52	104.6	51	124	18.96	91	196	4.849			
12	54	99.69	52	126	18.26	92	198	4.703			
13	55	95.05	53	127	17.58	93	199	4.562			
14	57	90.66	54	129	16.94	94	201	4.426			
15	59	86.49	55	131	16.32	95	203	4.294			
16	61	82.54	56	133	15.73	96	205	4.167			
17	63	78.79	57	135	15.16	97	207	4.045			
18	64	75.24	58	136	14.62	98	208	3.927			
19	66	71.86	59	138	14.09	99	210	3.812			

**Appendix 3:**

°C	10	11	12	13	14	15	16	17	18	19	20	21	22	23	24	25	26	27
°F	50	50	52	54	56	58	60	62	64	66	68	70	72	74	76	78	80	82
°C	28	29	30	31	32	33	34	35	36	37	38	39	40	41	42	43		
°F	84	86	86	90	92	94	96	98	98	99	100	102	104	106	108	109		
°C	44	45	46	47	48	49	50											
°F	111	113	115	117	118	120	122											

$$\Delta T(^{\circ}\text{F}) = \frac{9\Delta T(^{\circ}\text{C})}{5}$$



### 3. Compressor checking

Measure the resistance value of each winding by using the tester.

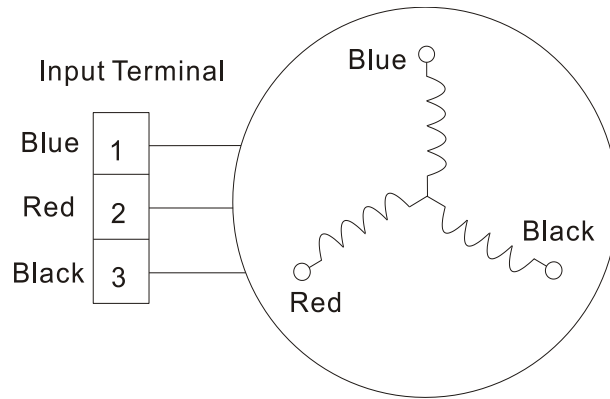

Position	Resistance Value		
	DA108X1C-23EZ	DA130M1C-31FZ	DA150S1C-20FZ
Blue - Red	1.1Ω	1.77Ω	0.95Ω
Blue - Black	(20°C/68°F)	(20°C/68°F)	(20°C/68°F)
Red - Blue			



### 3. IPM continuity check

Turn off the power, let the large capacity electrolytic capacitors discharge completely, and dismount the IPM. Use a digital tester to measure the resistance between P and UVWN; UVW and N.

Digital tester		Normal resistance value	Digital tester		Normal resistance value
(+)Red	(-)Black		(+)Red	(-)Black	
P	N	∞ (Several MΩ)	U	N	∞ (Several MΩ)
	U		V		
	V		W		
	W		(+)Red		

### 4: Indoor AC Fan Motor

Measure the resistance value of each winding by using the tester.

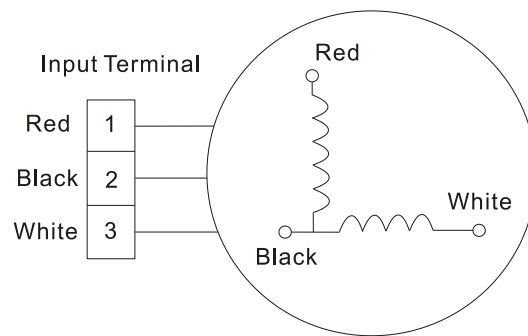

Position	Resistance Value			
	RPG15A	RPG28H	RPG45B	
Black - Red	75Ω±8% (20°C/68°F) (Brand: Weiling)	183.6Ω±8% (20°C/68°F) (Brand: Weiling)	112Ω±8% (20°C/68°F) (Brand: Weiling)	118.5Ω±8% (20°C/68°F) (Brand: Dayang)
White - Black	150Ω±8% (20°C/68°F) (Brand: Weiling)	206Ω±8% (20°C/68°F) (Brand: Weiling)	82Ω±8% (20°C/68°F) (Brand: Weiling)	78.5Ω±8% (20°C/68°F) (Brand: Dayang)

**5: Pressure On Service Port**  
**Cooling chart:**

°F(°C)	ODT		75	85	95	105	115
	IDT		(23.89)	(29.44)	(35)	(40.56)	(46.11)
BAR	70/59		8.2	7.8	8.1	8.6	10.1
BAR	75/63		8.6	8.3	8.7	9.1	10.7
BAR	80/67		9.3	8.9	9.1	9.6	11.2

°F(°C)	ODT		75	85	95	105	115
	IDT		(23.89)	(29.44)	(35)	(40.56)	(46.11)
PSI	70/59		119	113	117	125	147
PSI	75/63		124	120	126	132	155
PSI	80/67		135	129	132	140	162

°F(°C)	ODT		75	85	95	105	115
	IDT		(23.89)	(29.44)	(35)	(40.56)	(46.11)
MPA	70/59		0.82	0.78	0.81	0.86	1.01
MPA	75/63		0.86	0.83	0.87	0.91	1.07
MPA	80/67		0.93	0.89	0.91	0.96	1.12

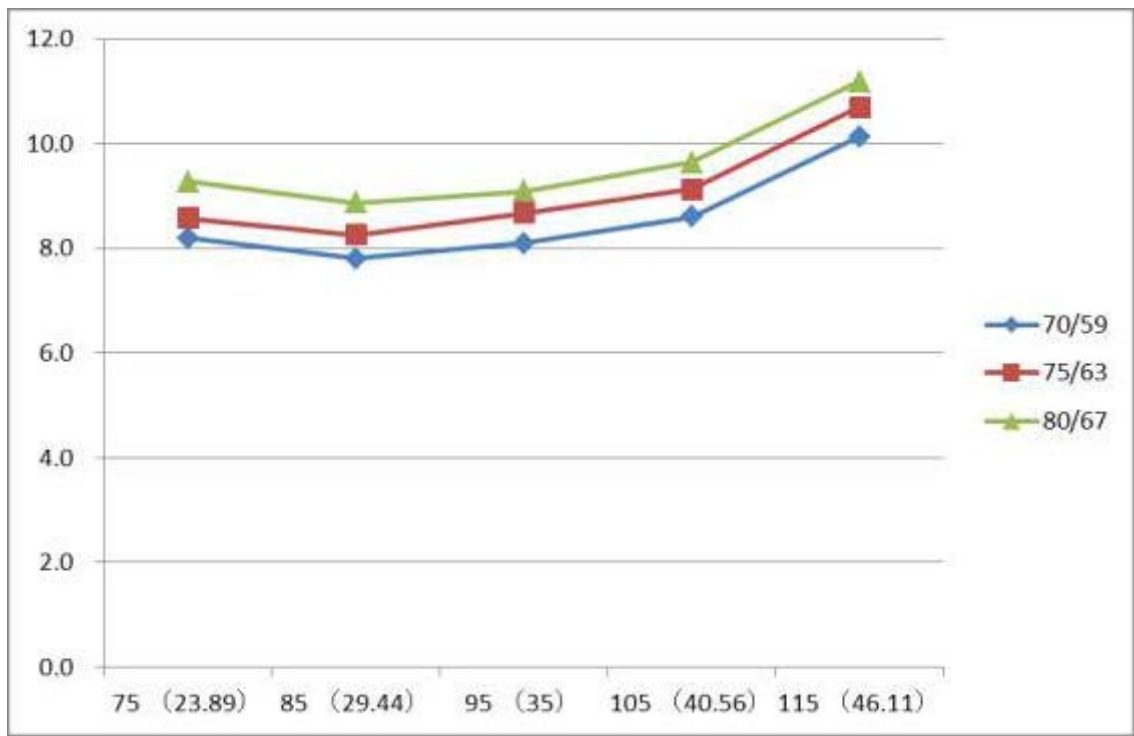

**Heating Chart:**

°F (°C)	ODT		57/53	47/43	37/33	27/23	17/13
	IDT		(13.89/11.67)	(8.33/6.11)	(2.78/0.56)	(-2.78/-5)	(-8.33/-10.56)
BAR	55		30.3	28.5	25.3	22.8	20.8
BAR	65		32.5	30.0	26.6	25.4	23.3
BAR	75		33.8	31.5	27.8	26.3	24.9

°F (°C)	ODT		57/53	47/43	37/33	27/23	17/13
	IDT		(13.89/11.67)	(8.33/6.11)	(2.78/0.56)	(-2.78/-5)	(-8.33/-10.56)
PSI	55		439	413	367	330	302
PSI	65		471	435	386	368	339
PSI	75		489	457	403	381	362

°F (°C)	ODT		57/53	47/43	37/33	27/23	17/13
	IDT		(13.89/11.67)	(8.33/6.11)	(2.78/0.56)	(-2.78/-5)	(-8.33/-10.56)
MPA	55		3.03	2.85	2.53	2.28	2.08
MPA	65		3.25	3.00	2.66	2.54	2.33
MPA	75		3.38	3.15	2.78	2.63	2.49

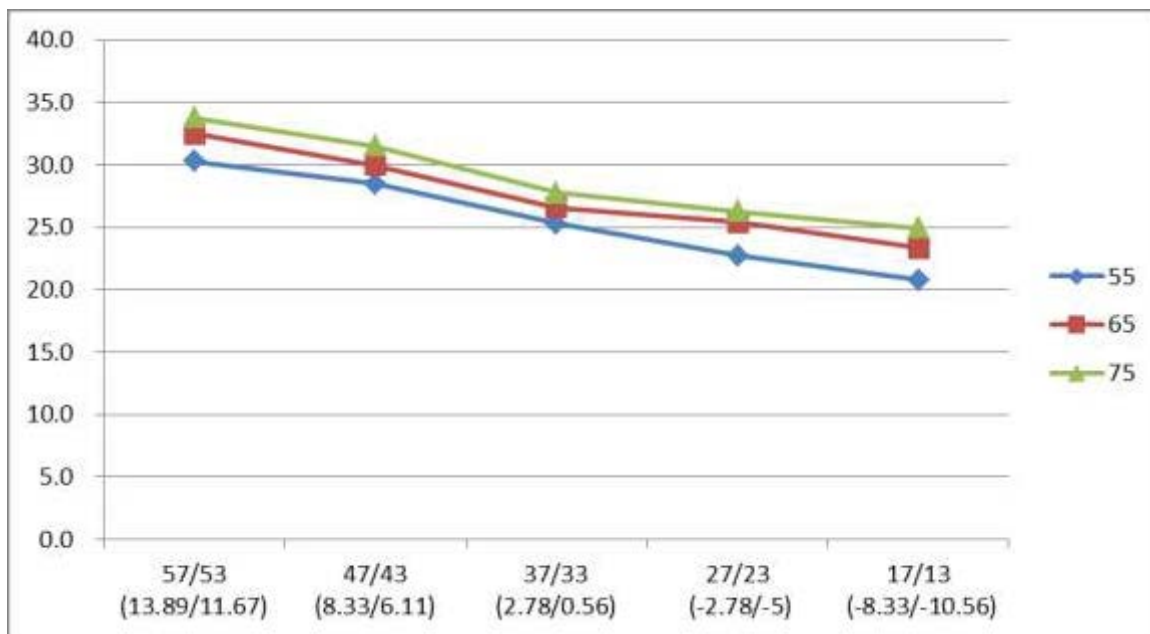



The Klimaïre logo is a registered Trademark of Klimaïre Products Inc.  
Copyright 2016 Klimaïre Products Inc.

2190 NW 89 Place, Doral, FL 33172 - USA

Tel: (305) 593-8358 Fax: (305) 675-2212  
[www.klimaïre.com](http://www.klimaïre.com) [sales@klimaïre.co](mailto:sales@klimaïre.co)

The design and specifications are subject to change without prior notice for product improvement.  
Consult with the sales agency or manufacturer for details.